

MOUNTING GRAPHIC

Snap Profile

1. Open the snap profile near the end without any tools.

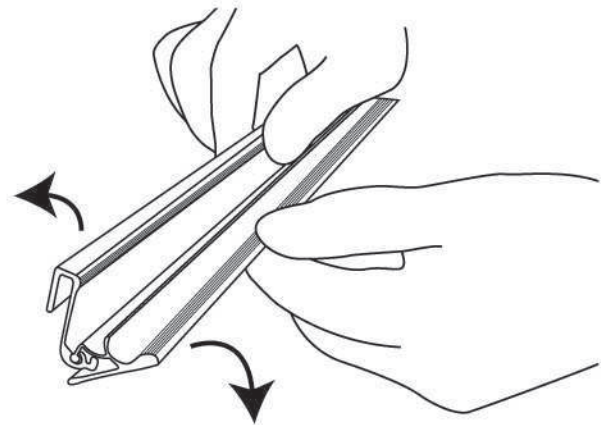
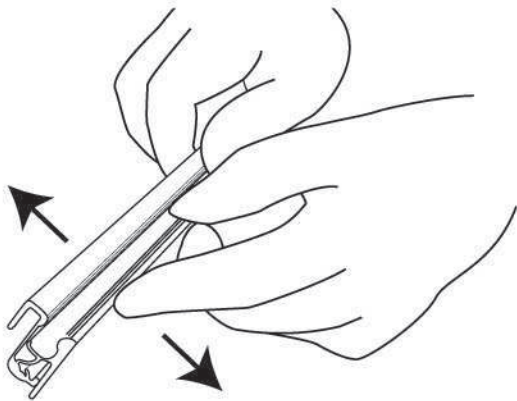

2. Insert the graphic into the profile and press hard.

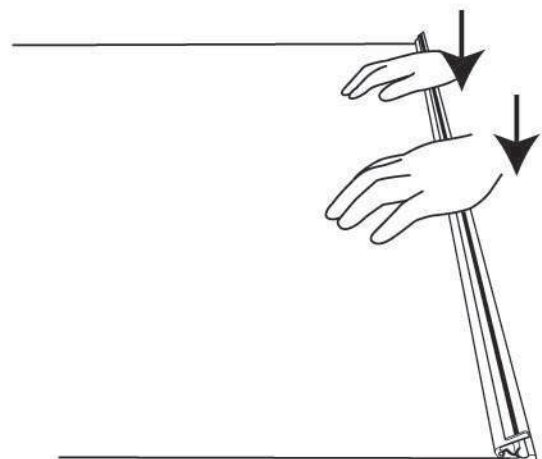
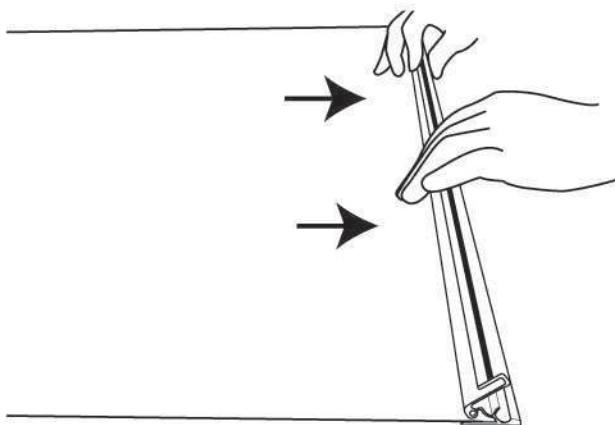

MOUNTING GRAPHIC

Part 2 - Attach Graphic Onto Base

1 Attach the bottom of the graphic by aligning it with the adhesive tape on the white PVC.

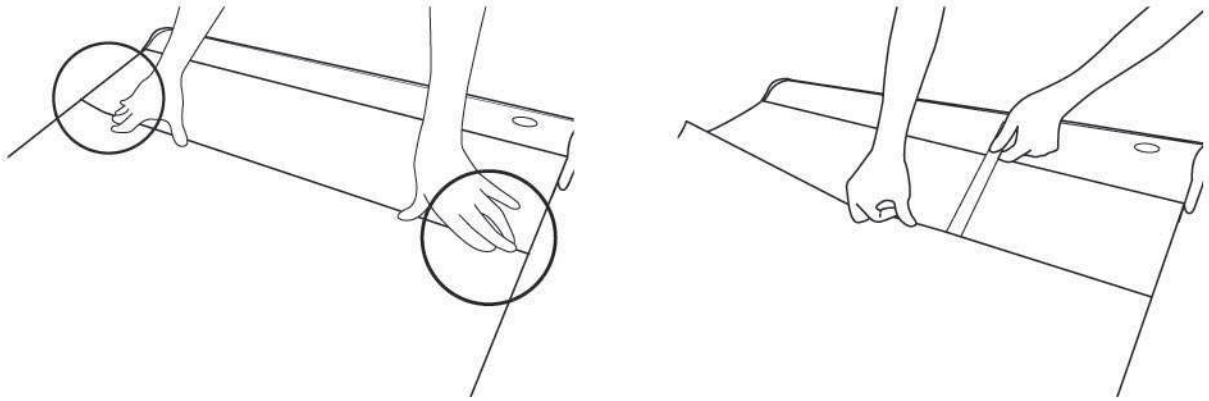

Press the graphic firmly and apply extra tape for reinforcement.

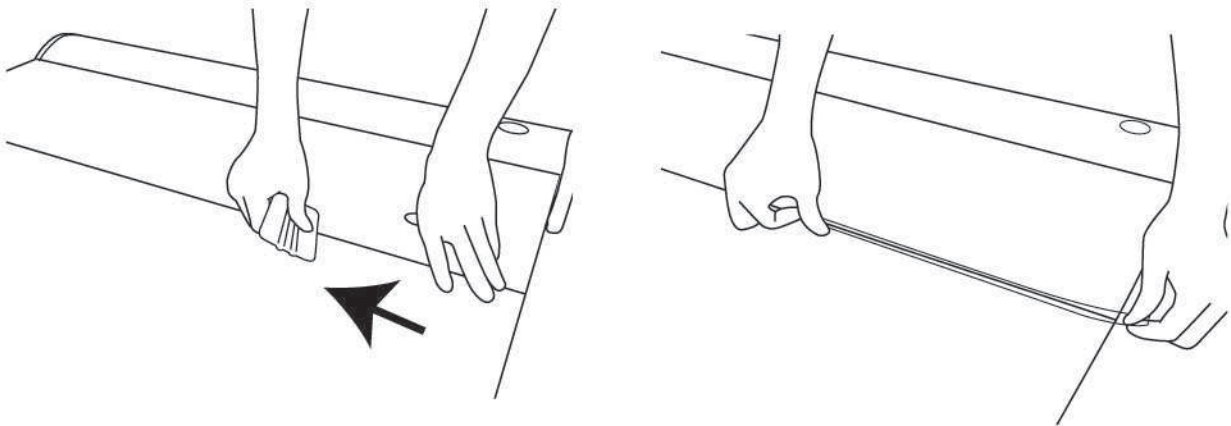

Hold the graphic while removing the key. Let the graphic retract into the base slowly.

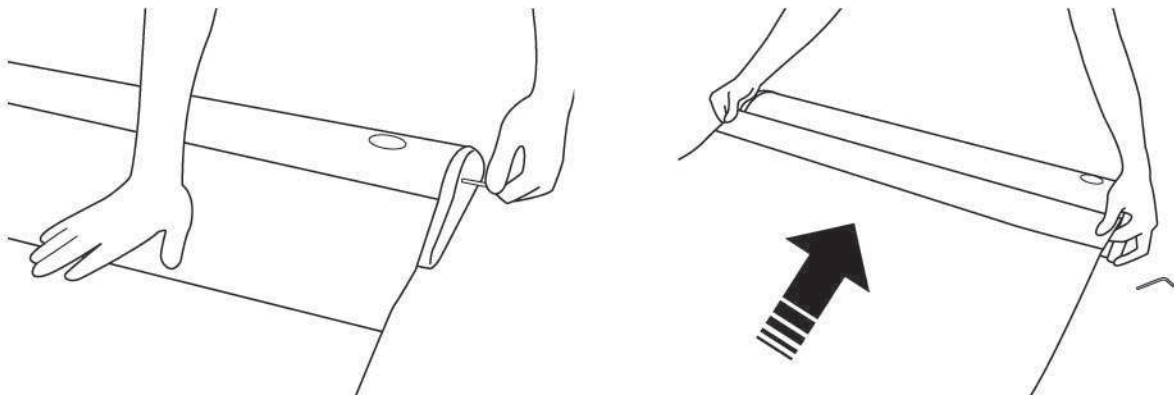

SET UP INSTRUCTION

1. Turn out the feet of the base.

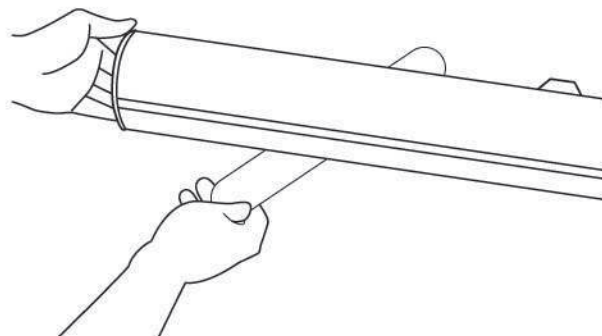
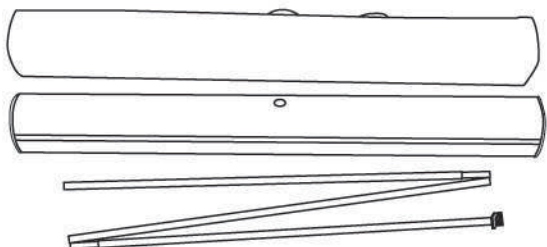

2. Unfold the 3-parted pole.

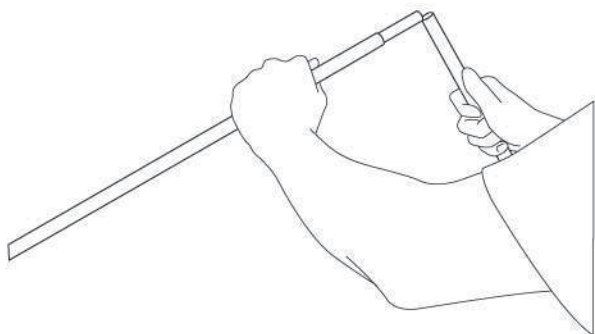

3. Pull up the graphic and position the plastic end tip of the pole into the top profile.

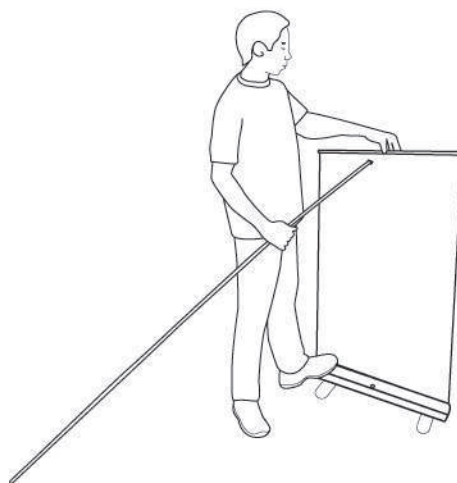

4. Insert the pole onto the cup of the base.

